

Varenummer: 0125059  
 Beskrivelse: Seeger låsering SP42  
 Fjederstål

## Mål

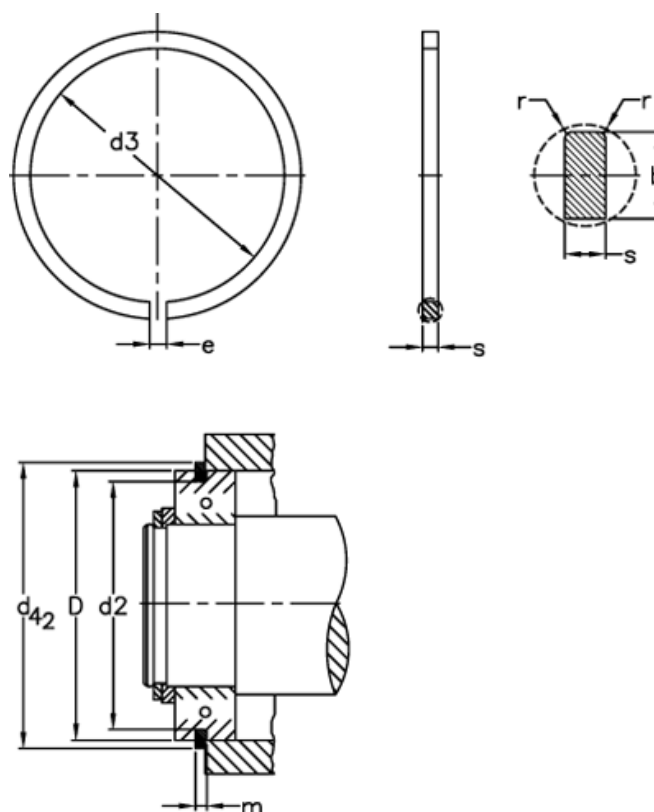

b	= 3.25	FRg kN	= 2.39	tol	= -0.15
Betegnelse	= SP 42	FR kN	= 12.9	tol	= -0.1
D	= 42	g	= 2.0	tol	= -0.25
d2	= 39.75	K kN-mm	= 23.4	tol	= 0.3
d3	= 38.9	m	= 1.35	tol	= 0.5
d42	= 46.3	n abl x 1000	= 7.0	vægt kg/1000	= 3.8
e	= 3	r min	= 0.4		
FN kN	= 23.5	s	= 1.12		